

NT Waterstops Installation Manual

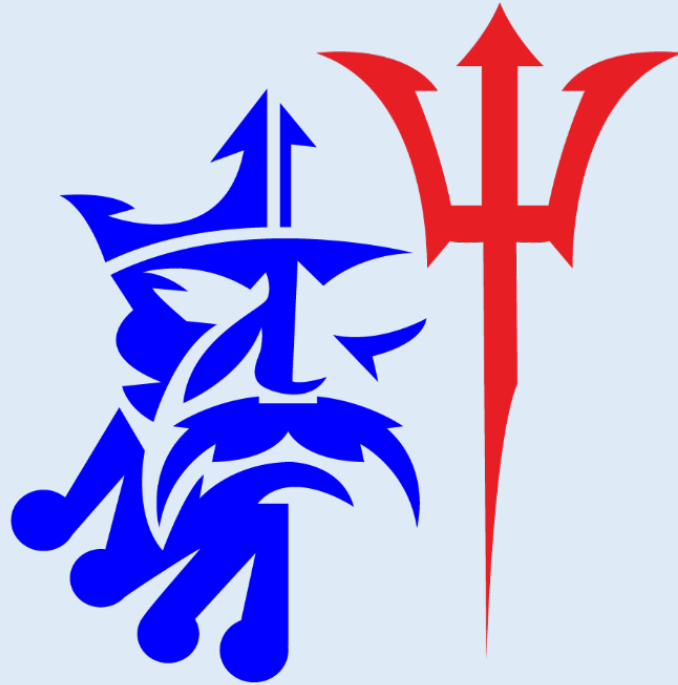

NEPTUNESTIDE

W A T E R S T O P S

Installed with:



Important Note:

For the NT Waterstop to function correctly all steps need to be followed precisely. Incorrect installation or failure to adhere to the guidelines/instructions set out in this document could result in unsatisfactory performance, or water migration out of the shower. Please also note that **the shower waste needs to be detailed correctly in accordance with AS:3740** for the NT Waterstop to work to its peak performance capabilities. **This includes having the waste set to the correct height, correct waterproofing detail around the waste, and having the drainage points unobstructed** etc.

NT waterstops are designed to be used with any waterproofing system, as long as the membrane that is to be used in the installation is capable of adhering to aluminium as per the manufacture's recommendations.

NT Waterstops will not be liable or held accountable for any issues resulting from incorrect installation.

The NT Waterstop is an ACCESORY to a waterproofing system, not a system in itself.



1. Preparing the Substrates for Adhesion

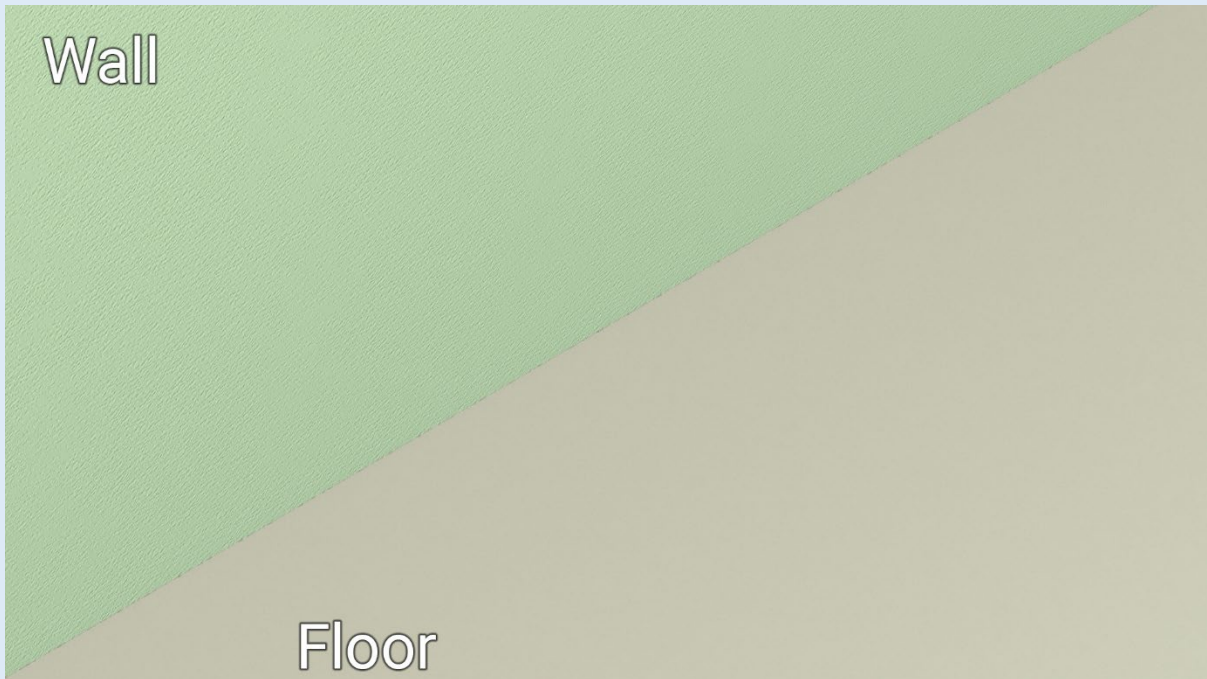

- ❖ Before installation of the NT Waterstop, **make sure the substrate and area where the NT Waterstop is to be installed is clean and free of debris.** It is important that this be done correctly to allow the adhesive, that is used to install the NT Waterstop, to properly adhere to the surface.
- ❖ From here, please be sure to apply GRIPSET GP Primer to the substrates in accordance with the manufacture's guidelines.

2. Installing the Corner Tape

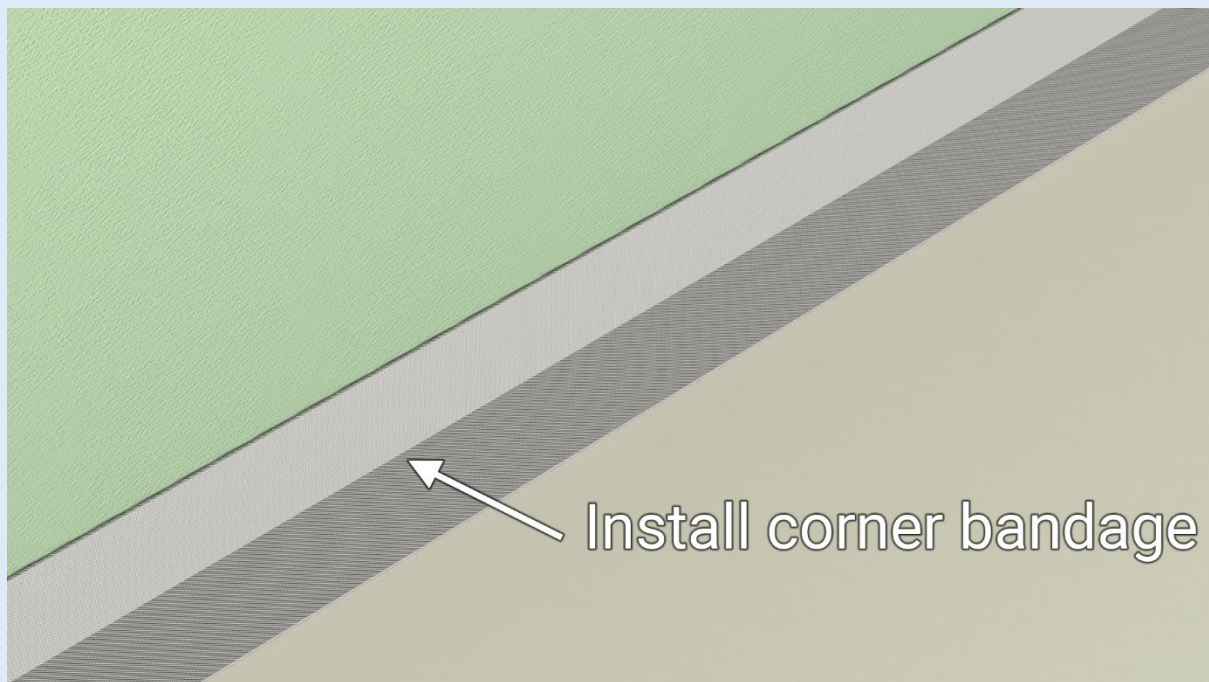

- ❖ Once the area has been **prepared in accordance with the manufacture's guidelines**, the GRIPSET BRW PF Tape can be installed.
- ❖ When installing the GRIPSET BRW PF Tape please make sure to keep the bubbles and ridges in the tape to an absolute minimum, this will allow the NT Waterstop to sit flush against the tape and make sure the NT Waterstop works correctly.
- ❖ A membrane band roller can be used on the band to help remove bubbles and ridges, and help the band adhere properly to the substrate.

3. Installing the NT Waterstop

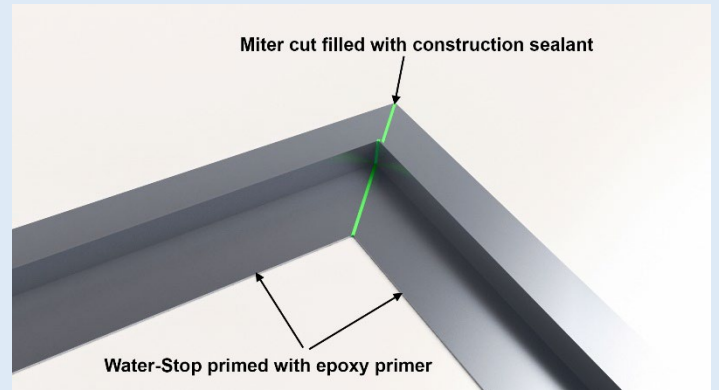
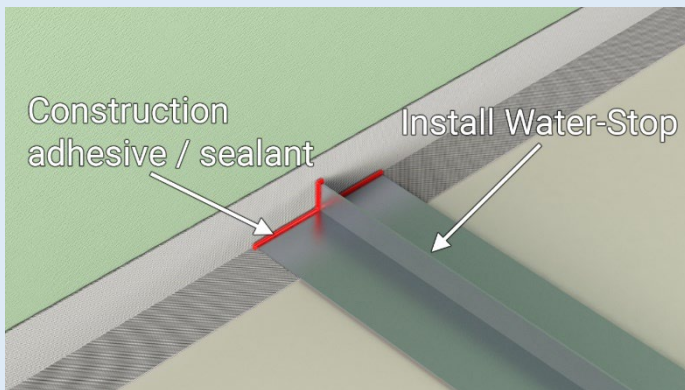

- ❖ Measure the area where the NT Waterstop is to be installed.
- ❖ Cut the NT Waterstop to length, **making sure to mitre the external corner and keeping the mitre tight to allow the NT Waterstop to work correctly.**
- ❖ Make sure the NT Waterstop is clean and dry. Apply the GRIPSET SB sealant/adhesive in two even beads along the length of the bottom of the NT Waterstop.
- ❖ Install the NT Waterstop onto the substrate, making sure to firmly push the NT Waterstop down to allow the adhesive to bond correctly to the substrate.
- ❖ Once the NT Waterstop has been installed, apply the GRIPSET SB sealant/adhesive to the external and internal corners and termination points to fully seal the NT Waterstop in place.
- ❖ On the internal corner of the external mitre, **make sure to apply a sealant fillet at least 6mm wide from the bottom of the vertical leg to the top**, making sure to smooth it off for ease of detailing.

4. Installing the band either side of the NT Waterstop

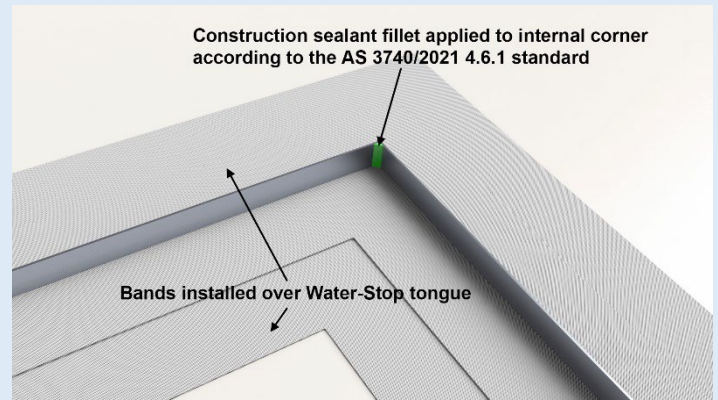
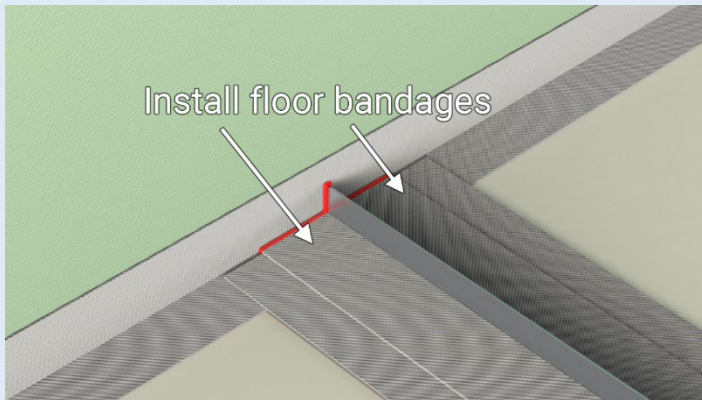

- ❖ Once the NT Waterstop has been installed correctly, the GRIPSET BRW PF Tape can be applied to both sides of the NT Waterstop to seal it in place.
- ❖ When the GRIPSET BRW PF Tape is installed on both sides of the NT Waterstop, **the tape should come up to the bottom of the vertical upstand** to allow maximum coverage of the tape onto the NT Waterstop.
- ❖ Use a membrane band roller to removes any ridges or bubbles in the band.

5. Applying the saddle flashing

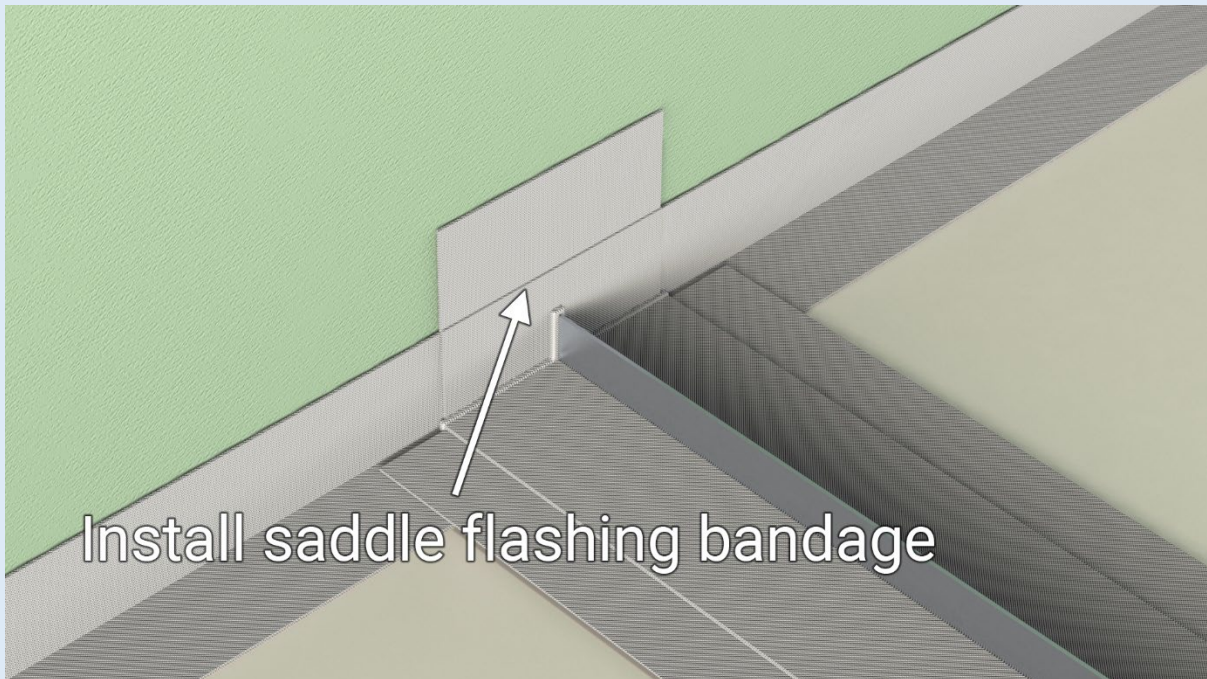

- ❖ Once the GRIPSET BRW PF Tape has been installed either side of the NT Waterstop, a saddle flashing is to be **applied over the termination point** to aid in sealing the NT Waterstop.
- ❖ To achieve this, a piece of GRIPSET BRW PF Tape is used, a cut the same length as the vertical upstand of the NT Waterstop is made into the centre of the tape, and the tape can then fit right over the top of the NT Waterstop on the termination point with it lapping down tightly onto the existing tape and over the GRIPSET SB sealant/adhesive.
- ❖ Use a membrane band roller to removes any ridges or bubbles in the band.

6. First Coat of Membrane

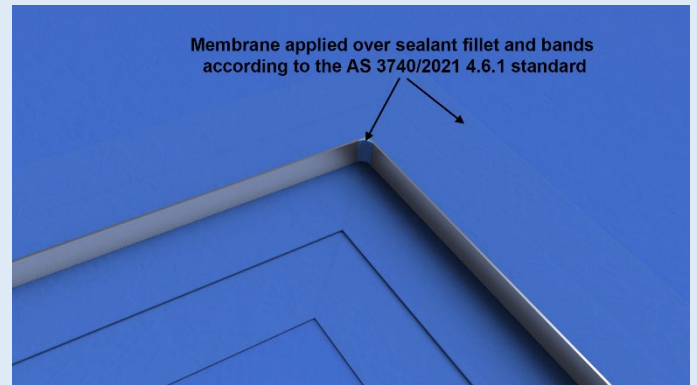
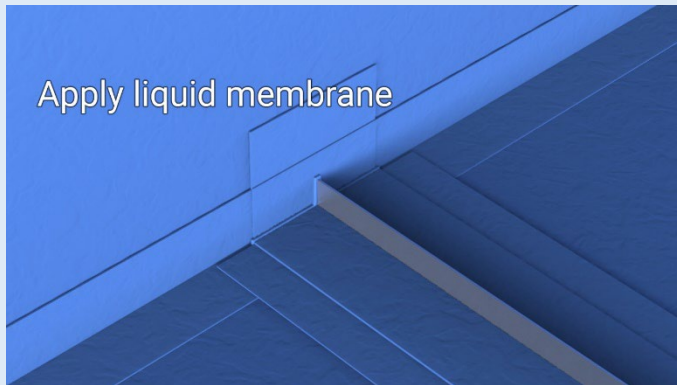

- ❖ Once the saddle flashing has been applied, the first coat of membrane can be applied to the shower/bathroom floor.
- ❖ Careful attention should be paid to correct dry film thickness and internal corner details.
- ❖ Make sure to **apply waterproofing over the internal corner of the external mitre, where the sealant fillet is**, this allows the waterstop to be completely sealed.
- ❖ **Remember to follow all technical data sheets** from the manufacturer to ensure the waterproofing is applied correctly and within the manufacturer's specifications and guidelines.
- ❖ Please wait the appropriate amount of time as dictated by the manufacturer before continuing with the next step to make sure the membrane has fully cured.

7. Installing the NT Wall Waterstop

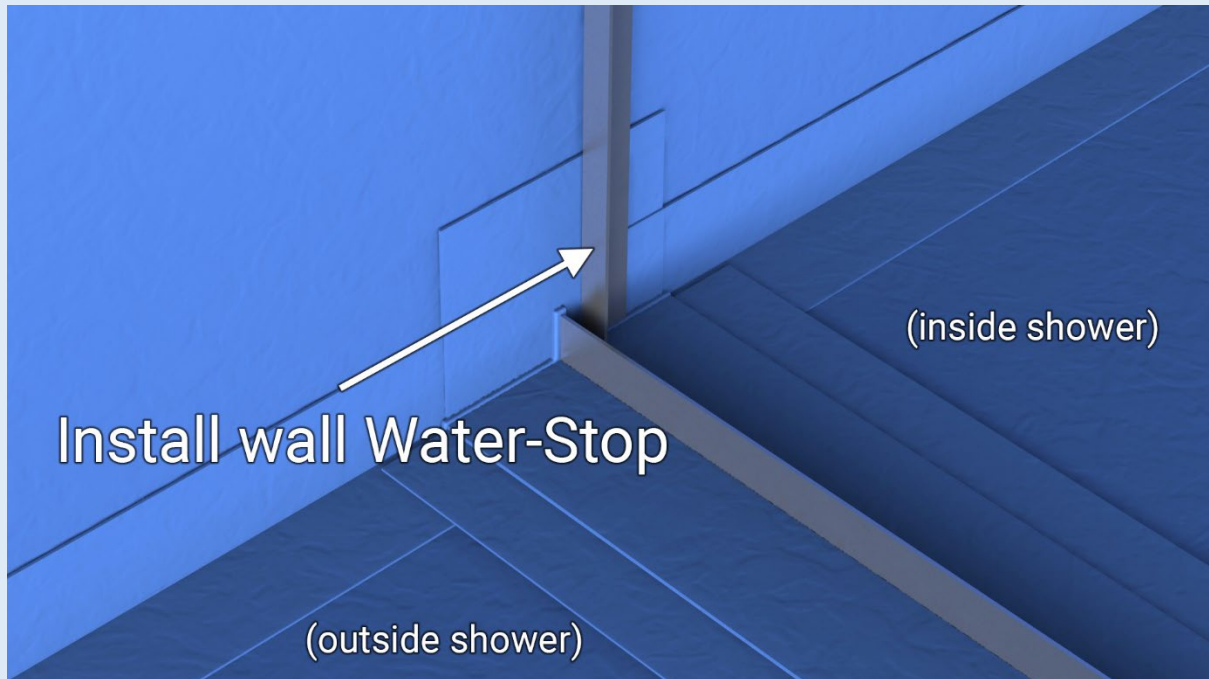

- ❖ Once the first coat of membrane has dried the NT Wall Waterstop can be installed.
- ❖ Using a spirit level or laser level, level a pencil line **approximately 10mm** from the NT Floor Waterstop on the inside of the shower where the shower glass wall channel will sit.
- ❖ Once a level line has been created, GRIPSET SB sealant/adhesive can be applied to the back of the NT Wall Waterstop and the Waterstop can be applied to the wall.
- ❖ Take care when installing the Waterstop to **apply it level and flat** on the shower wall, doing this will make tiling easier and ensure that the Waterstop works correctly.

8. Installing the Wall Bandage

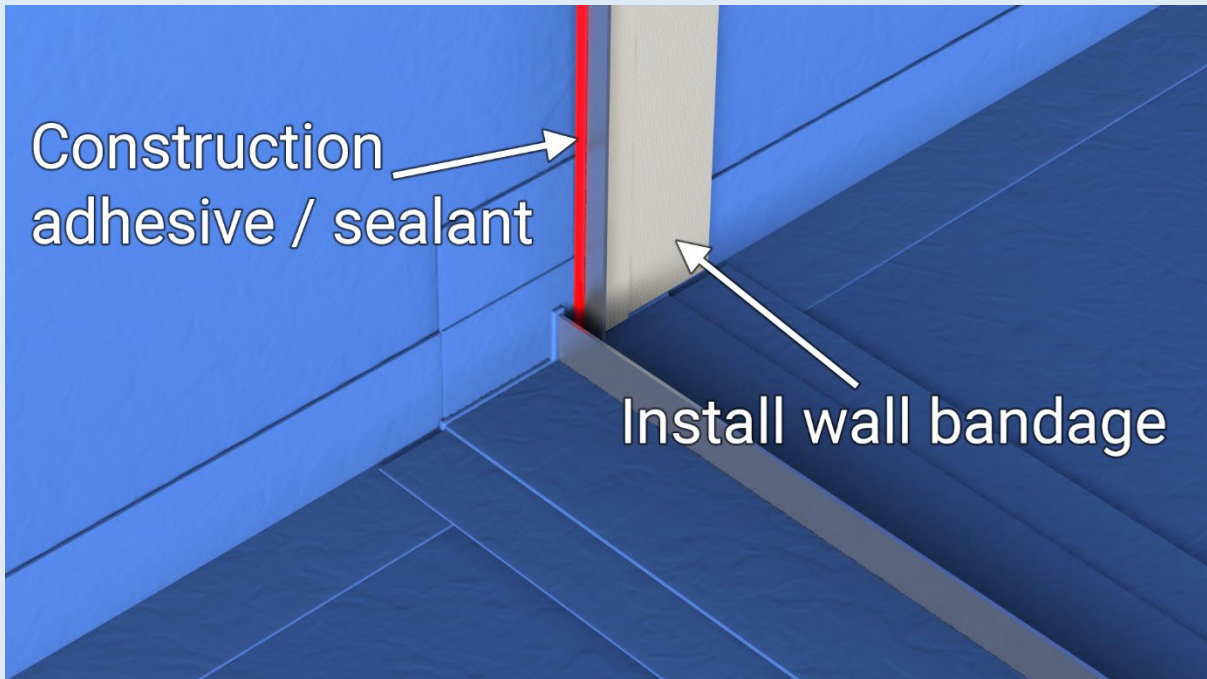

- ❖ After installing the NT Wall Waterstop measure and cut the GRIPSET BRW PF Tape to the same length as the NT Wall Waterstop.
- ❖ Carefully apply the bandage onto the NT Wall Waterstop so it overlaps from the NT Wall Waterstop onto the existing membrane.
- ❖ Use a Membrane Band roller to firmly adhere the bandage to the surface of the existing membrane.
- ❖ Using GRIPSET SB sealant/adhesive, seal the front edge of the NT Wall Waterstop as shown in the diagram above, and clean off any excess.

9. Applying the Second Coat of Membrane

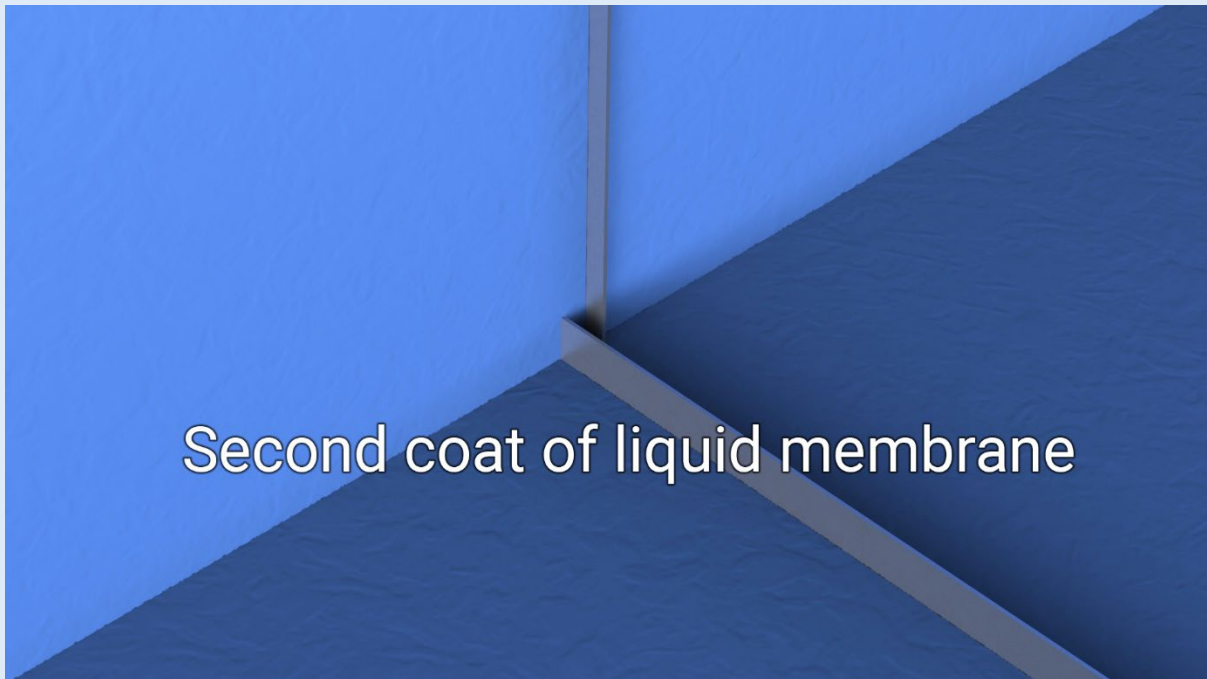

- ❖ After the band has been applied to the NT Wall Waterstop, the second coat of membrane can be applied.
- ❖ **Remember to follow all technical data sheets** from the manufacturer to ensure the waterproofing is applied correctly and within the manufacturer's specifications and guidelines.
- ❖ Please wait the appropriate amount of time as dictated by the manufacturer before continuing with the next step to make sure the membrane has fully cured.

10. Finished (Ready for Tiles)

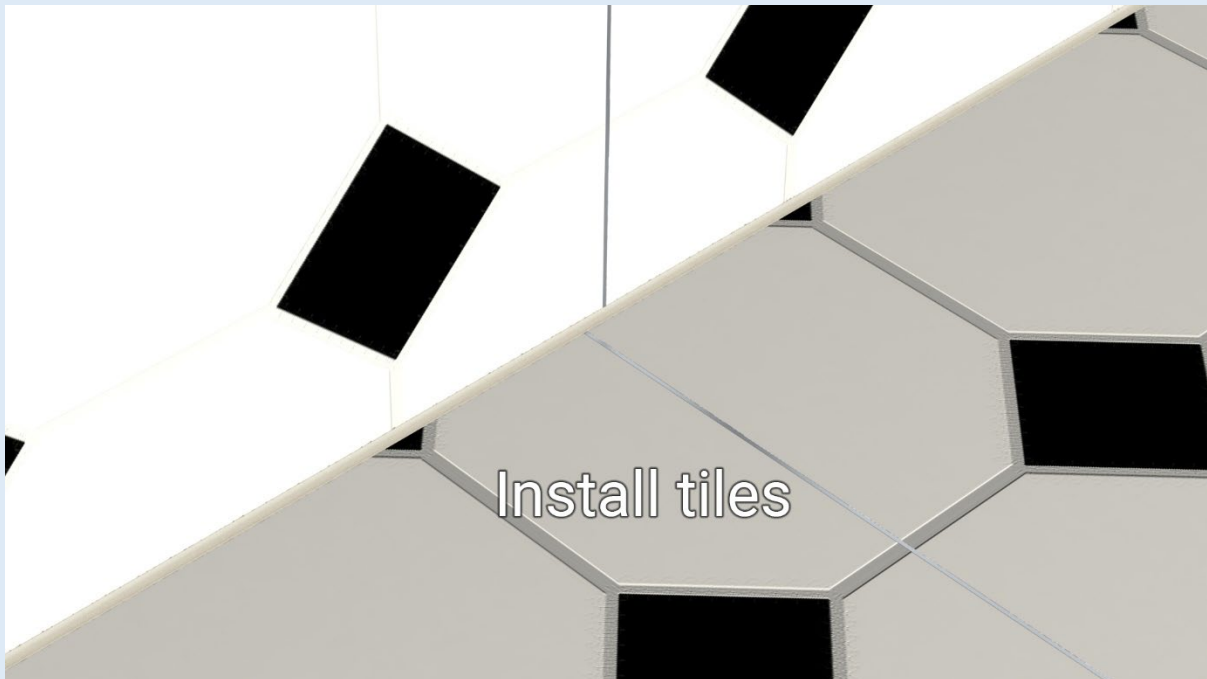

- ❖ Once this is completed the shower is ready to be tiled! The Glass Channel is installed over the wall waterstop and slightly behind the floor waterstop, so they remain unseen.
- ❖ Please make sure all membranes are applied within the manufacture's guidelines, and special care is taken regarding the correct dry film thickness and membrane cure times.
- ❖ The principal for membrane application is the same with all NT Waterstops.
- ❖ The NT Waterstop is designed to have the waterproofing terminate at the bottom of the vertical upstand, the waterproofing **can** be applied to the vertical upstand but should not be applied **directly over the top** of the vertical upstand. This is to allow ease of tiling and detailing when it comes to that part of the tiling process.
- ❖ Remember that regular maintenance of the shower is important. The NT Waterstop is designed to stop water migration from occurring **UNDER** the tiles. If the shower is not installed correctly or there is a lack of maintenance, water may make its way out from the shower area. NT Waterstops are meant to be installed as per the instruction manual, if they are not, NT Waterstops takes no responsibility or ownership of any incorrect applications. NT Waterstops are designed as an **ACCESORY** to a waterproofing system, not a system itself, if the membrane system is incorrectly applied, NT Waterstops is not liable for any damages and holds no responsibility for incorrect application or usage.